

PIPE-150-1015

500 lb WLL

1.5" DIA. OVERHEAD TELESCOPING PIPE EXTENDER

XTENDER™



The PIPE-150-SERIES offers installers the ability to lower and raise items that are suspended from above. This Adjustable Pipe offers 8 different extensions in increments of 3/4" between 10" and 15".

Adaptives PIPE-150-SERIES works with a variety of our overhead mounting products such as our Unistrut mounting product line as well as wood and metal beam clamps.



Strut Mounted

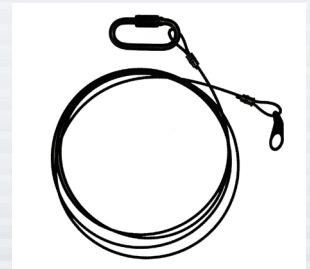

Safety Cable Included

STANDARD FEATURES:

- ▶ Telescoping pipe offers a range of extensions
- ▶ Adapts to multiple overhead mounts.
- ▶ 3/4" incremental adjustment

OPTIONAL ACCESSORIES:

- ▶ MP-1.5NPT-GSA Gimballed Mount
- ▶ MP-1.5NPT-TA Strut Mount
- ▶ MP-1.5NPS-CP Ceiling Mount
- ▶ MM-3RDX-120 Speaker Mount

SPECIFICATIONS:

Outer Tube: Structural Steel Tube
Inner Tube: Structural Steel Pipe
Finish: Powder Coat
Color: Black
WLL: 500 lb. 226.796 kg max
Vertical Orientation Only
Design Factor: 7:1 ratio

PACKAGE CONTENTS:

1pc Telescoping Pipe
1pack Hardware Kit



Rated for indoor use.

DIMENSIONS:

RETRACTED

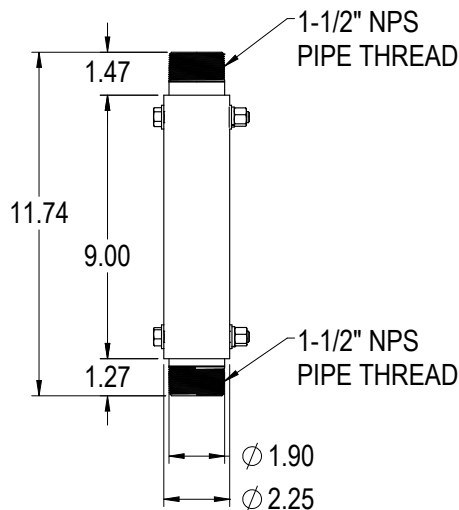

EXTENDED

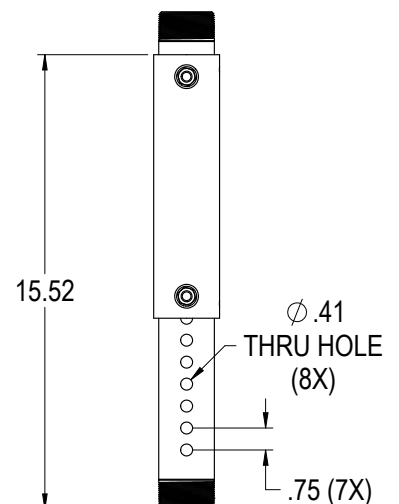

Gimballed Mount

Strut Mount

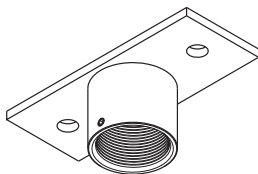
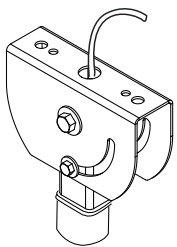

Ceiling Mount

Speaker Mount

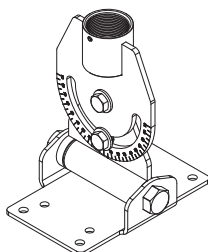
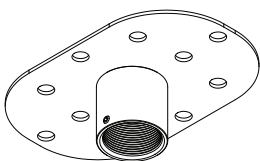

Adaptive Technologies Group

1635 E. Burnett Street | Signal Hill, CA 90755 USA
Ph: 562.424.1100 | Fax: 562.424.3520
www.adaptivetechologiesgroup.com



ALWAYS INSTALL SAFETY CABLES

WARNING: Mounting and/or suspension of equipment requires experienced professionals. Improperly installed equipment can result in property damage, personal injury and/or liability to the installing contractor.