

MC-030-B

1650 lb WLL

2" TRUSS CLAMP

TRUSS CLAMP



Truss Clamp with Speaker Bracket

This high-strength, all-aluminum Truss Clamp adapts to 2" diameter truss cord and pipe, which provides a secure suspension point for audio, video and lighting equipment.

The MC-030-B comes with a quick-set truss clamp lock and a 10mm diameter hex bolt, nut and washer for attaching items such as yokes to the clamp. In addition, Eye nuts, couplers, threaded rod and pipe couplings are available that allow you to adapt the truss clamp to any suspended application.



Quick Set Latch

STANDARD FEATURES:

- ▶ Adapts to yokes, eye nuts, threaded rod and pipe
- ▶ Wing-style clamping lock
- ▶ Light weight, all aluminum housing
- ▶ Attachment hardware included

OPTIONAL ACCESSORIES:

- ▶ MC-EN-KT Suspension Kit
- ▶ See Threaded Rod datasheet
- ▶ 1/2" Pipe Coupler CG-500NPS-PEC
- ▶ 1-1/2" Pipe Coupler CG-150NPS-PEC
- ▶ See Pipe Extension datasheet

SPECIFICATIONS:

Material: Aluminum
Finish: Anodize
Color: Black
WLL: 1650 lb / 750 Kg
Safety Factor: 5:1
Weight: 0.63 Kg (1.40 lbs)

PACKAGE CONTENTS:

1 pc Truss Clamp
1 pc Flat Washer M10 X 40
1 pc Split Flat Washer M10

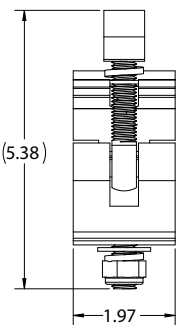

End View

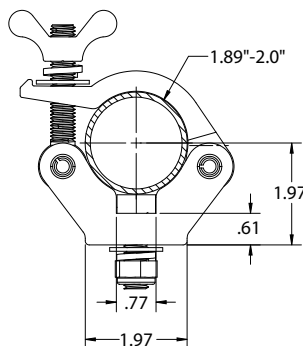

Front View

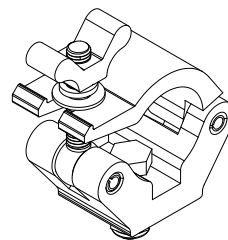

Isometric View

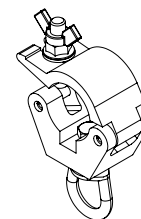

Eye Nut Kit

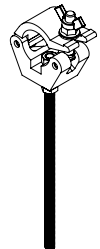

1/2" Threaded Rod

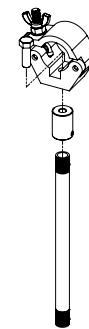

1/2" Pipe & Coupler

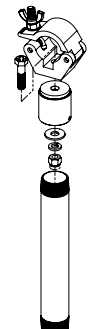

1-1/2" Pipe & Coupler

ALWAYS INSTALL SAFETY CABLES

WARNING: Mounting and/or suspension of equipment requires experienced professionals. Improperly installed equipment can result in property damage, personal injury and/or liability to the installing contractor.