

# SBC12-17-CA-30

# 430 lb WLL

## Swivel Arm Beam Clamp With Rotating Suspension Arm

## BeamWare®



Pan & Tilt from I-Beam

Swivel Structural Beam Clamps are time-saving rigging solutions that provide a safe and load-rated method of securing loads from horizontal Beams. Once anchored to a beam, they provide a simple and reliable method for aiming loudspeakers and other objects.

Swivel Beam Clamps secure to a building's overhead structural beams, steel or wood, for widths ranging from 12" to 17" (305 to 432mm) wide.

It's lower suspension arm rotates 360 degrees for precise aiming.



U-Bracket Option



Wood Beam Option  
Vertical Orientation



Dual Tilt Kit Option  
Horizontal Orientation

### STANDARD FEATURES:

- ▶ Quick Mount & Aim, attaches to I-Beams
- ▶ Provides safe load-rated suspension
- ▶ Powder Coated Black

### OPTIONAL ACCESSORIES:

- ▶ AJ-2336 - Adjustable U-Bracket
- ▶ TCK Series - Adjustable Tilt Cable Kit
- ▶ TCK2 Series - Adjustable Tilt Cable Kit
- ▶ FC Series - Fixed Length Wire Rope Assemblies
- ▶ BC-LAM-KIT - Laminated Beam Adapter Kit

### SPECIFICATIONS:

**Materials:** Structural Steel Alloy  
**Finish:** Powder Coat  
**Color:** Black  
**Pan Rotation:** 360°  
**WLL:** 430 lb / 195.5 Kg  
**Design Factor:** 7:1 Ratio  
**Product Weight:** 19.2 lb / 8.7 Kg

### PACKAGE CONTENTS:

**1pc:** Beam Clamp  
**1pc:** Swing Arm  
**2pc:** Eyebolts  
**1bag:** Hardware Kit



1/4" Eyebolt  
Included  
Suspension  
Option

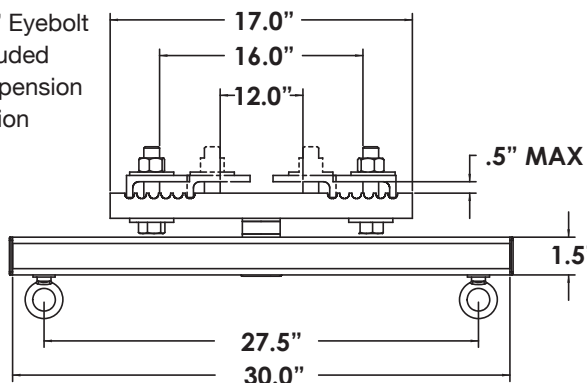

AJ-2336 U-Bracket  
Suspension  
Option

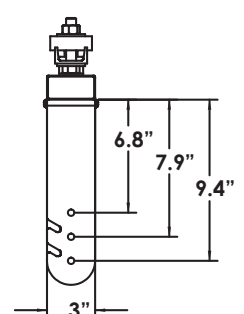
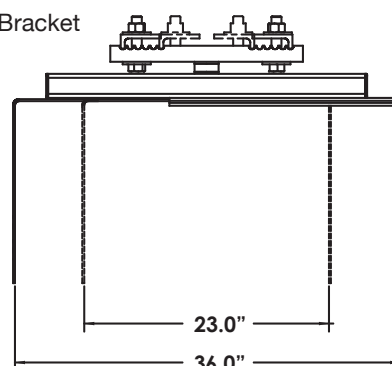
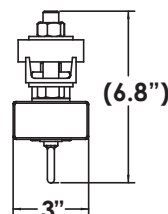

**Adaptive Technologies Group**  
1635 E. Burnett St. | Signal Hill, CA 90755 USA  
Ph: 562.424.1100 | Fax: 562.424.3520  
www.adaptivetechgroup.com



### ALWAYS INSTALL SAFETY CABLES

**WARNING:** Mounting and/or suspension of audio and video equipment requires experienced professionals. Improperly installed loudspeakers can result in property damage, personal injury and/or liability to the installing contractor.