

## FEATURES:

- Up to 16 x 9 video wall configurations
- Includes Single-column extension
- Fast set ups and dismantling
- Light-weight aluminum construction
- Telescoping two-column T-Base floor module
- Telescoping Back Brace
- Adjustable floor levelers
- Built in X and Z axis bubble levels
- Rugged black powder coat finish
- Aircraft pins for quick assembly
- Ballast anchor points and tie downs
- Rolling cart with 6" locking casters
- Fits inside delivery truck width-wise
- Cart top converts to table
- Easy to use ballast calculator
- Fork Lift Compatible
- Supports 500mm & 500 X 1000mm tiles including Absen A3 Pro, A5, A6T, A7, X3, X5 & X7, M2.9, Unilumen 3.9, Unilumin U PAD, CreateLED, SquareV and PixLED video

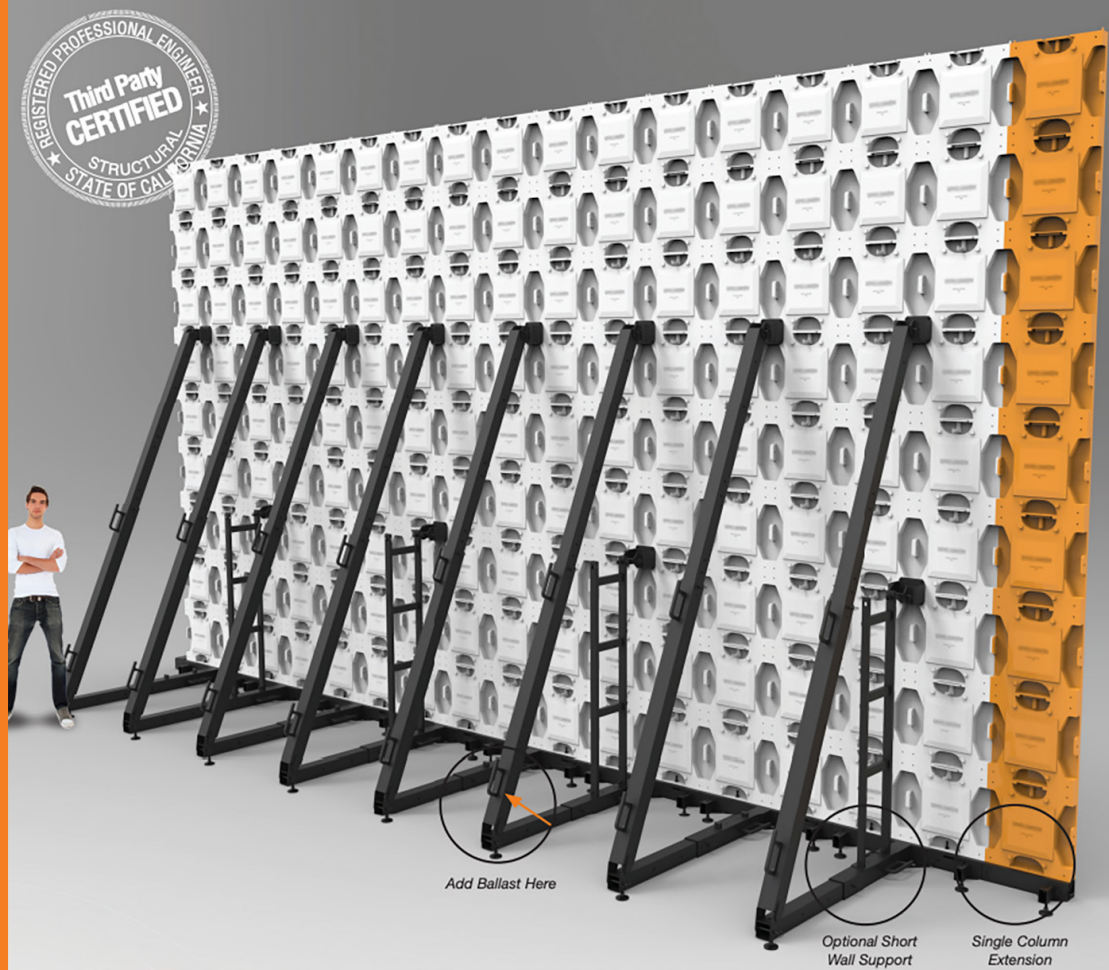

## Assemble 16X9 Video Walls Fast

This innovative ground support system includes everything you need to set up video walls. Quickly build up to 16 LED tiles wide and 9 LED tiles tall using 500 mm LED monitors. Or add the single column extension to assemble a 17 X 9.

Loc-N-Load® sets up and packs up in half the time that it takes using conventional ground support methods.

The Loc-N-Load's telescoping T-Base supports two vertical columns of LED tiles (up to 9 high). They connect leveling to the next T-Base and to the next, etc. Each T-Base is equipped with three leveling gliders as well as X and Z axis bubble levels so your crew can get the first tier of monitors locked into the same plane quickly.

The telescoping Back Brace connects to the back of the T-Base and extends upward to the 4th, 5th and 6th tiers as the T-Base extends outward. This provides a higher reach and an anchor point to the upper tier monitors as the video wall grows higher.

When dismantled, all of the T-Bases, Back Braces and Back Stays quickly stow onto the rolling cart, along with the single-column T-Base extension. Cart weight fully loaded is less than 850lbs.



Rolling Cart



## Compatible LED Tiles

LEDs used on Single Column T-Bases must interlock with each other. T-Bases serve only as a leveling platform for LEDs.

## In-line Connection

Connect multiple LED tiles in a straight line



Dual T-Base    Single T-Base

## Convex / Concave Curve

Connect LED tiles in a convex or concave curve, tile-to-tile up to 5° +/-\*



T-Bases - Curved Connection

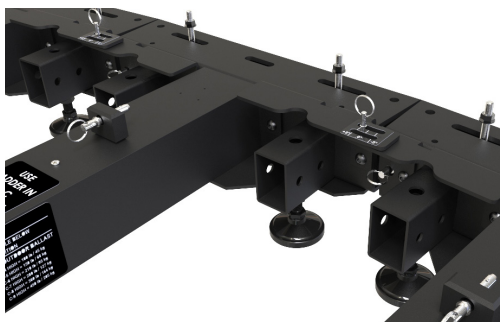

T-BASE Connection

## CONVEX CURVE

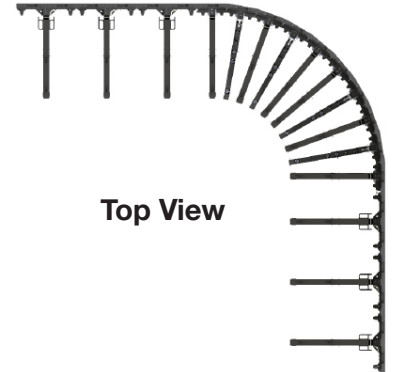
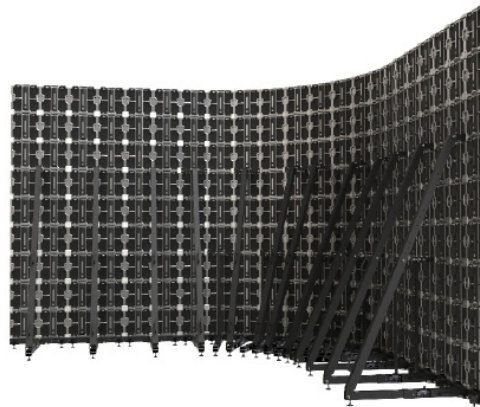

Top View

This is a typical example of a video wall display utilizing both Single-Column and Dual-Column T-Bases. Single-Column T-Bases form the curve with the LED monitors facing out and the Dual-Column T-Bases continue the straight sections.

## CONCAVE CURVE

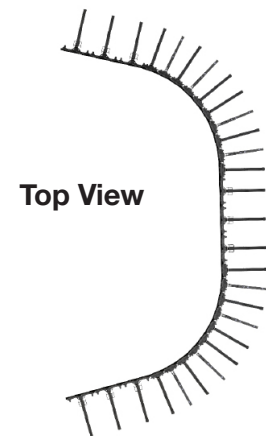
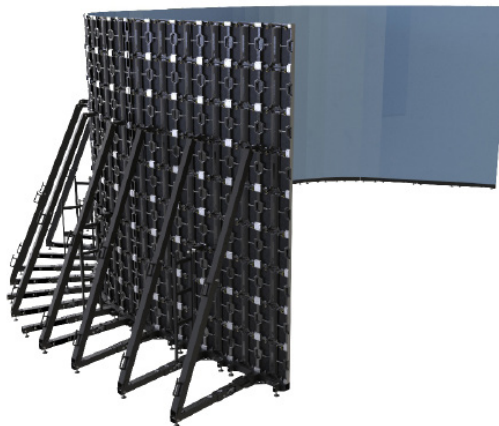

Top View

Like the Convex configuration, this is a typical example of a concave video wall display utilizing both Single-Column and Dual-Column T-Bases. Single-Column T-Bases form the curve with the LED monitors facing in and the Dual-Column T-Bases continue the straight sections.

\*tile to tile angle and wall radius dependant upon selected LED model



## Rear Supports



### Ladder Support GS-LADDER-5

This 5-foot tall Brace connects to the T-Base and Back-Stay to support 5-high video walls.

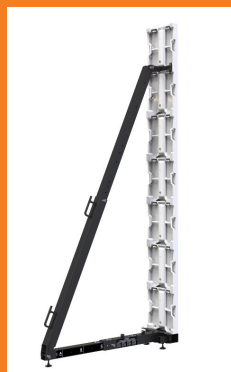

### Telescoping Brace Support GS-BRACE

This Brace connects to the T-Base and Back-Stay to support video walls ranging in height from 6 monitors high to 9 monitors high.

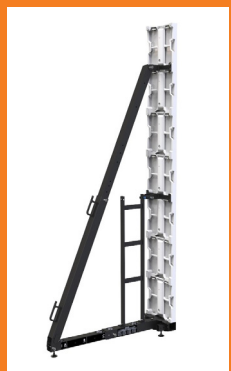

### Brace and Ladder Support

If the selected LED tile lacks rigidity or is subjected to wind, use both the Ladder Support and Telescoping Brace Support when stacking 7, 8 or 9 tiles high.

## T-Base Connections

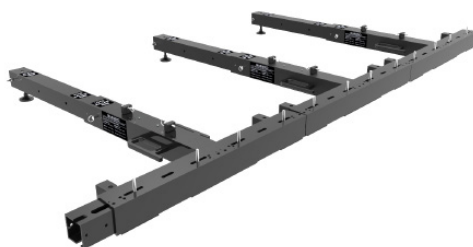

### Dual Column LED Connection

The T-Base serves as a leveling platform that supports vertical columns of LED monitors. The selected LED must be an interlocking design as they support the columns from left to right. Form any configuration straight or curved display, up to 5° depending on the selected monitor.

\*Use Dual-Column T-Bases for straight sections to save time and use fewer components.

## Universal Back-Stay Connections

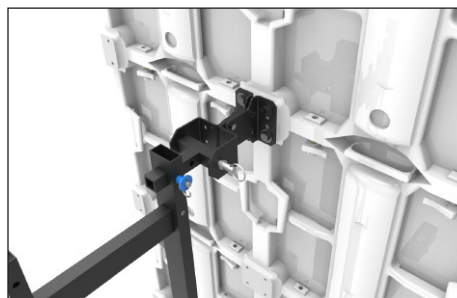

[Click here for a list of LED adapters](#)



GS-BCKSTY-DS

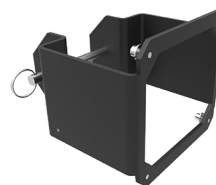

GS-BACKSTAY

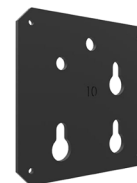

LED ADAPTER

The Back-Stay connects to the LED tile via the only non-universal component in the system, an LED adapter. It connects to both Support Ladders and Telescoping Brace Supports to the LED tile via a unique tile-specific adapter. Both require this adapter to bridge between the back support and the selected LED monitor. If your selected LED is not on the list on the left side of this page, contact customer service at [sales@adaptivetechologiesgroup.com](mailto:sales@adaptivetechologiesgroup.com) or call 562-424-1100.



## Optional Accessories

### Short Wall Support - GS-LADDER-5



Blank Tile Spacer 500 mm X 500 mm  
GS-BT-500X500



Blank Tile Spacer 500 mm X 1000 mm  
GS-BT-500X1000

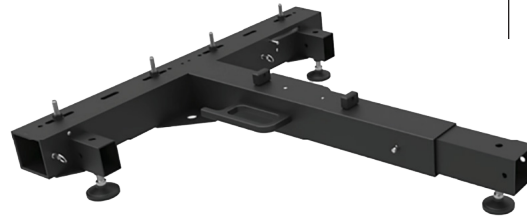
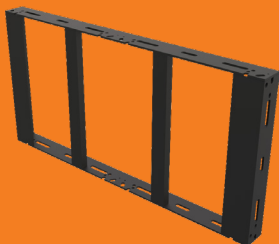

Dual Column Telescoping T-Base

Connect bases to other bases side by side as needed, in-line or in a curve. Each base accommodates two 500mm x 500mm LED monitors. Build two vertical columns up to 4500mm tall. The back telescopes out as the video wall gets taller. A bubble level and adjustable feet provide fine-tune leveling.

GS-T-BASE

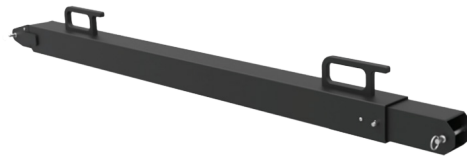

Support video walls six or more monitors high (3000 mm +). Its lower clevis-style end connects to the T-Base. Its top connects to the universal back stay using an adapter plate that secures to the LED tile. See page 3. Ballast handles are used to hang sand-bags and strap down to decks.

Telescoping Back Brace GS-BRACE



Back Brace Connection to T-BASE

Single Column Extender  
GS-T-BASE-EXT



Attach the Extender to the right side of a dual column T-Base to add one more column of LED tiles.

Front Ski Set  
GS-SKI



Adds stability to the front of short video walls by placing one foot on the left and one on the right.

## Optional Accessories

### Cart Cover (GS-CART-CVR)

Save space on the truck or warehouse. This rugged Cart Cover interlocks with the cart and built from a black painted aluminum frame and thick plywood top.



### Folding Table & Cover (GS-CART-TABLE)

This cover design opens into a convenient work bench for tools and wiring. It interlocks with the cart and comprised of a black painted aluminum frame, plywood top and folding legs. It measures 84" long X 34" wide X 30" tall.



### Cart Stacker (GS-CART-IF)

Save space in the warehouse by stacking a fully loaded cart atop another cart with a fork lift using this black painted sturdy aluminum frame. **This product is not to be used during transport.**



## Rolling Cart GS-CART-BSC

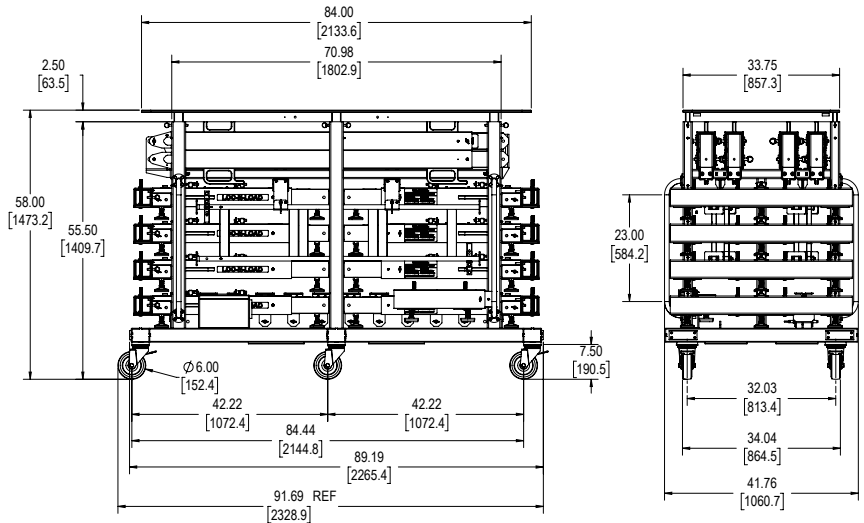

## Loc-N-Load® Rolling Cart

The Loc-N-Load® Rolling Cart holds all of the components that are necessary to assemble LED video walls ground support system, up to 17 monitors wide and 9 monitors tall. The cart's rugged tubular aluminum frame stows eight two-column ground support assemblies, eight back braces and one single-column base extension.

The cart's finish is powder-coated in black and rolls on 6" locking casters. Corner bumpers protect its frames while being transported and all the ground support components lock into the cart with quick release fasteners.

The removable top converts into a set up table and provides a way to stack additional gear. Its length stows inside a delivery truck length-wise up against the cab.

## A, B and C Positions

The Loc-n-Load® interlocking ground support system has three positions that the telescoping T-Base and back brace lock into as rows of monitors are added.

After laying down the T-Bases and locking them together, you can set 4-5 rows of monitors utilizing the A position. Add a 6th row of monitors and extend the t-base and back brace into the B position. Add a 7th row of monitors and extend the t-base and back brace out to the C position. Once in the C position you can add an additional 2 rows of monitors for the maximum height.

Always load counter balancing ballast when assembling the Loc-n-Load® video walls. Look for the "Load Ballast Here" labels.



### WARNING:

**BALLAST WEIGHT MUST BE ADDED DURING ASSEMBLY. PLEASE REFER TO WEIGHT TABLE BELOW.**

#### OUTDOOR USE:

Position A = 480lb / 218kg  
Position B = 514lb / 234kg  
Position C = 907lb / 412kg

#### INDOOR USE:

Position A = 264lb / 120kg  
Position B = 230lb / 104.5kg  
Position C = 277lb / 126kg

Outdoor working loads are based on a maximum of 40 mph to the back of a fully assembled 16X9 Video Wall.

## Extreme Positions Shown Below

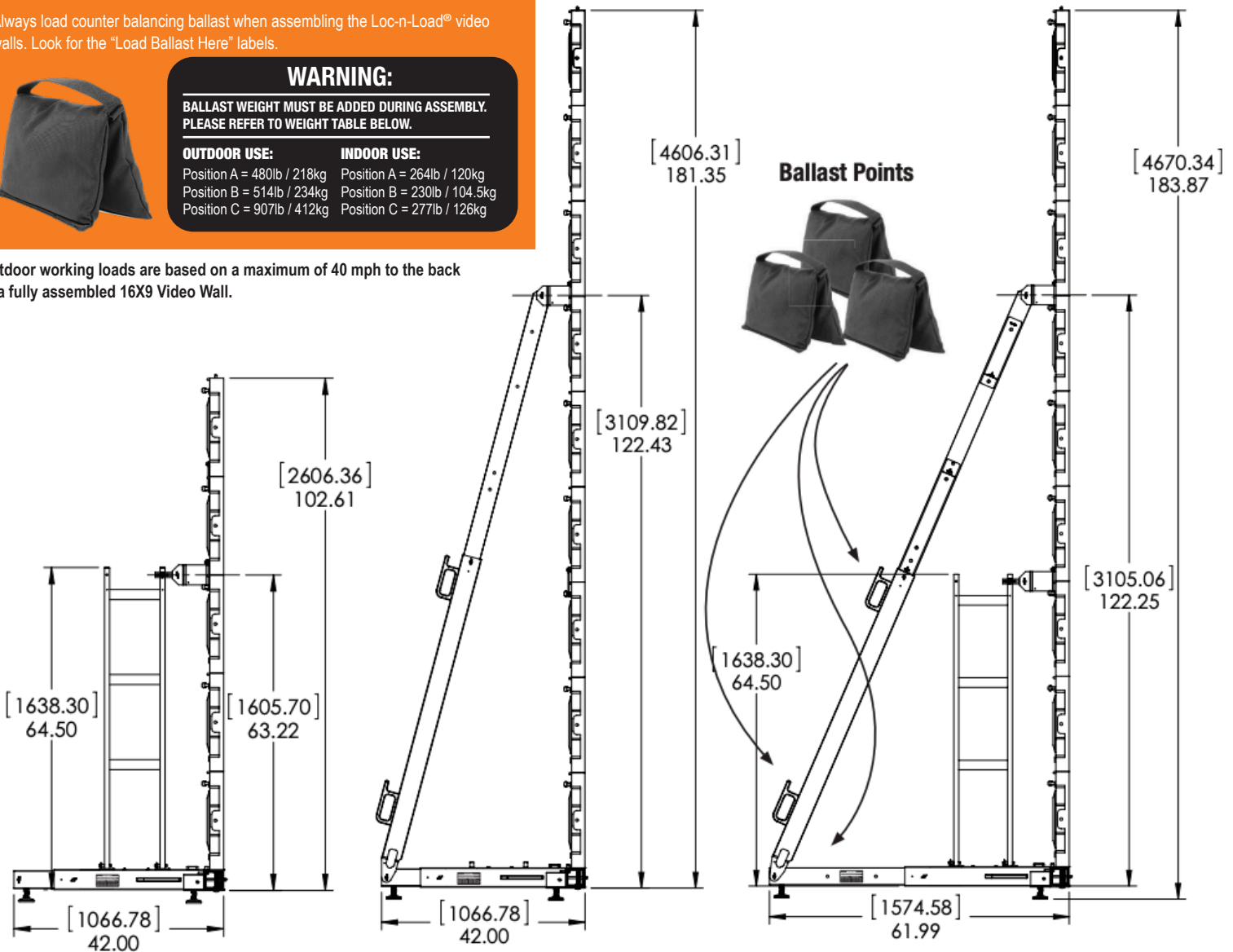

**3-5 Tiles High**

**A - Position with Short Wall Support**

**9 Tiles High**

**A - Position with Back Brace**

**8-9 Tiles High**

**C - Position with Back Brace**



**ALWAYS INSTALL SAFETY CABLES**

**WARNING:** Do not assemble Loc-N-Load® video walls without first adding counterbalancing ballast. Weights and or straps must be applied to the Loc-N-Load® ground support system to secure the video wall. See ballast table in instruction manual or on side of T-Base for safe installation and use.

