

Installation Guide

BC-2824-6

Offset Beam Clamp

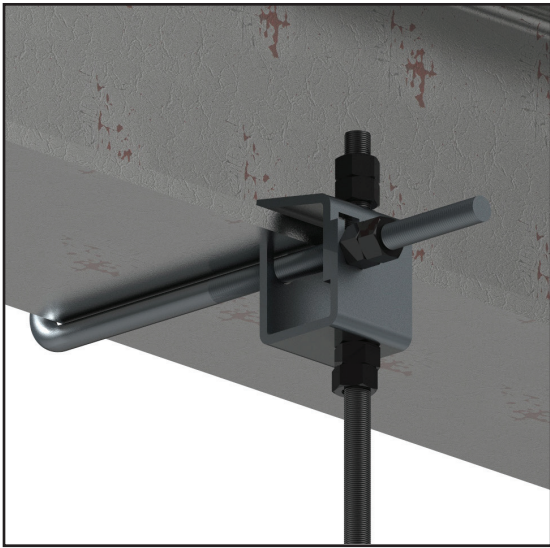

The BC-2824-6 is an adjustable hook style off-set beam clamp that mounts flush underneath the building's I-beam's flange. It provides a load rated overhead rigging point from structural I-beams with widths ranging from 2" to 6".

Contents:

Be sure that all of the following items are included in this kit before proceeding:

- 1 pc Beam Clamp
- 6 pc Hex Nut, 1/2-13
- 1 pc 12" All Threaded Rod
- 1 pc. Instruction sheet

Installation Procedure:

OPTION 1: USING ALL THREAD ROD

Step 1:

Loosely assembly the threaded rod into the beam clamp using the provided 1/2 -13 hex nuts and flat washer (Figure 1).

Step 2:

Position and hook the beam clamp under one side of the I-Beam then push and secure the upper and lower clamps onto the other side. Thread in the hex nut until upper and lower clamps are snug to the edge of the I-Beam.

Figure 2

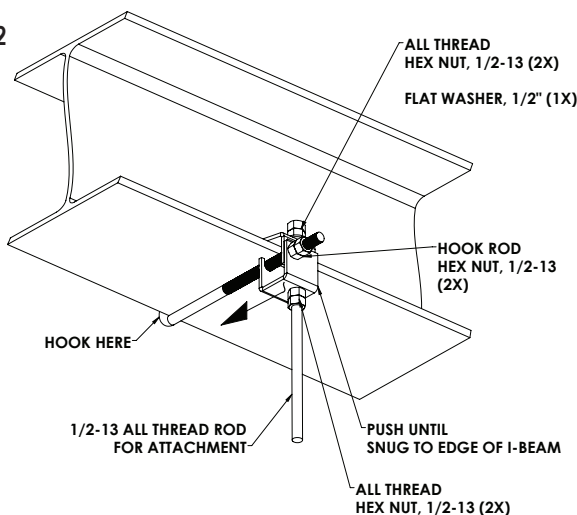
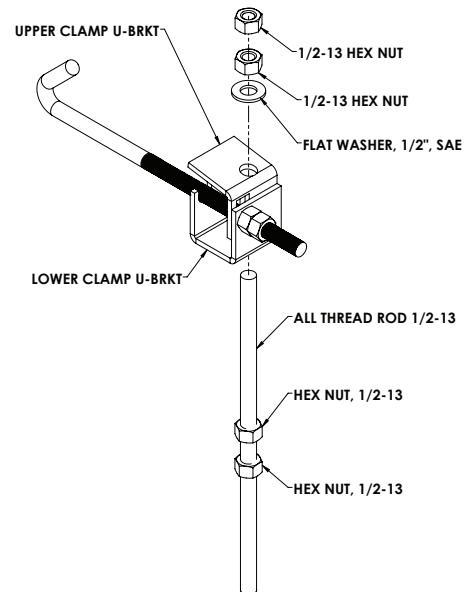

Figure 1



Step 3:

Snugly tighten the hex nut of the hook rod and the upper and lower hex nuts of the threaded rod. (Figure 2).

Step 4:

Position beam clamp final location and permanently tighten the first nuts first and use the second hex nut as locking nuts.

Step 5:

Check all connections and hardware before attaching other load rated hardware.

Note to installers:

Due to the wide variety of wall structures, materials and mounting methods, the installing contractor must exercise proper judgment in selecting the mounting area and hardware.

As a guide, the installation, when complete should be capable of supporting 5 to 10 times the actual applied load. Always use a backup safety system such as a safety cable.

To assure a trouble-free installation, read through and follow these instructions carefully before beginning. If you have doubts about the integrity of the structure you are mounting to or you are not sure about the proper hardware to use, consult a structural and/or hardware specialist.

Installation Guide

BC-2824-6

Offset Beam Clamp

OPTION 2: USING BOLTS

Step 1:

Position and hook the beam clamp under one side of the I-Beam then push and secure the upper and lower clamps onto the other side. Thread in the hex nuts until upper and lower beam clamps are snug to the edge of the I-Beam. (Figure 3).

Step 2:

Insert the 1/2-13 Hex bolt (sold separately) from under the lower Clamp (with attached isolation hanger if being used) and up into the hole of the upper clamp. Secure using provided flat washer and hex nuts. Snugly tighten the hex nut of the hook rod and the upper hex nuts of the Hex bolt. (Figure 4).

Step 3:

Snugly tighten the hex nut of the hook rod and the upper hex nuts of the eyebolt. (Figure 7).

Step 4:

Position beam clamp final location and simultaneously permanently tighten the first nuts first and use the second hex nut as locking nuts.

Step 5:

Check all connections and hardware before attaching other load rated hardware.

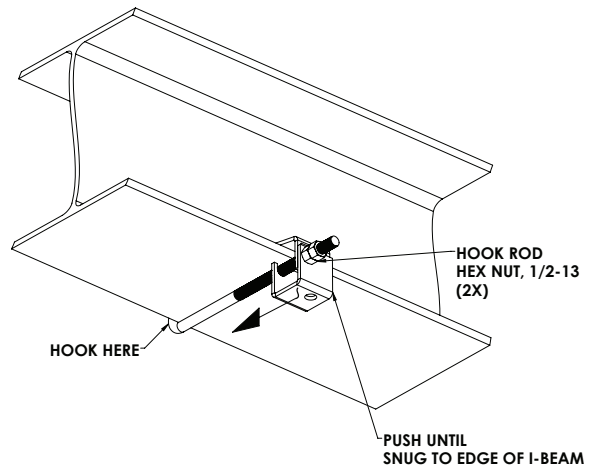

Figure 3

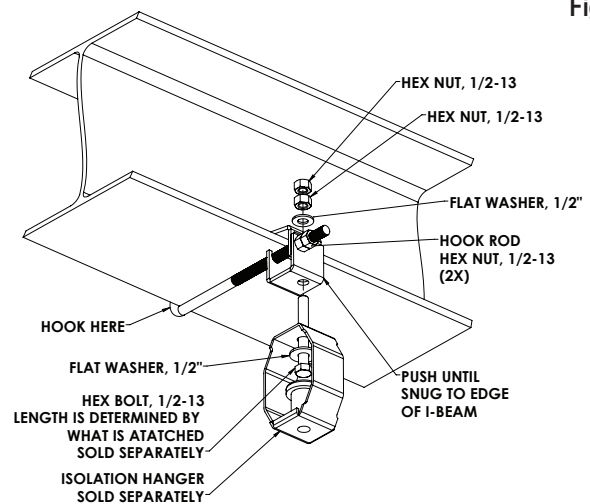

Figure 4

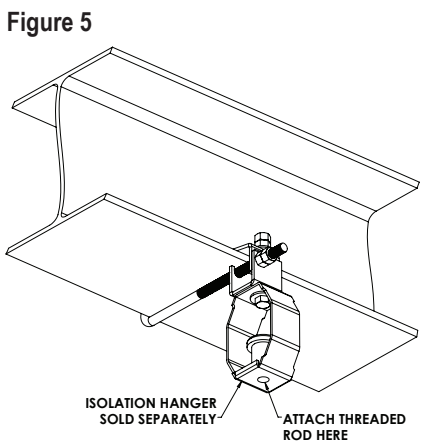

Figure 5

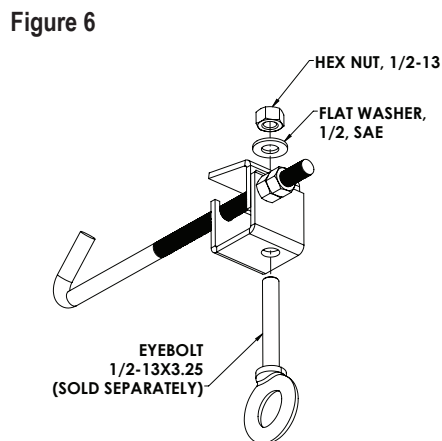

Figure 6

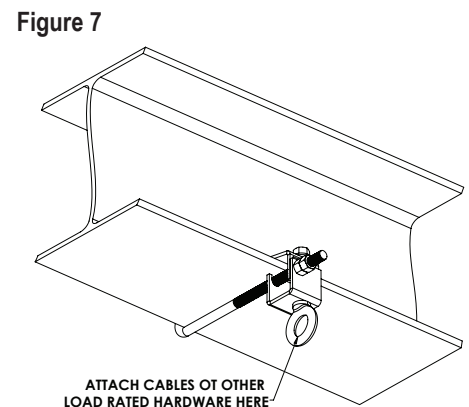

Figure 7

ALWAYS INSTALL SAFETY CABLES

WARNING: Mounting and/or suspension of audio and video equipment requires experienced professionals. Improperly installed loudspeakers can result in property damage, personal injury and/or liability to the installing contractor.