

# BS3-60X6

## STEEL BAND ROUND SLINGS

## SPAN SET



Choker Suspension with Shackle

Steel band round slings are used to suspend objects such as loudspeakers and video walls from overhead lighting truss, structural beams and pipe. Its internal cord is constructed using galvanized steel aircraft cable wound in an endless configuration, which lends itself for high working loads and fire-safe installations. Its soft external fabric cover is easy to handle and protects the finish of suspended surfaces. Its black color blends in with theatrical applications.



Steel Core Construction

### FEATURES:

- ▶ Fabric Covering Protects Surfaces
- ▶ Internal Steel Banding - Fire Safe
- ▶ High Working Load

### ACCESSORIES:

- ▶ Shackle Data Sheet SK Series
- ▶ End Link Data Sheet EL Series

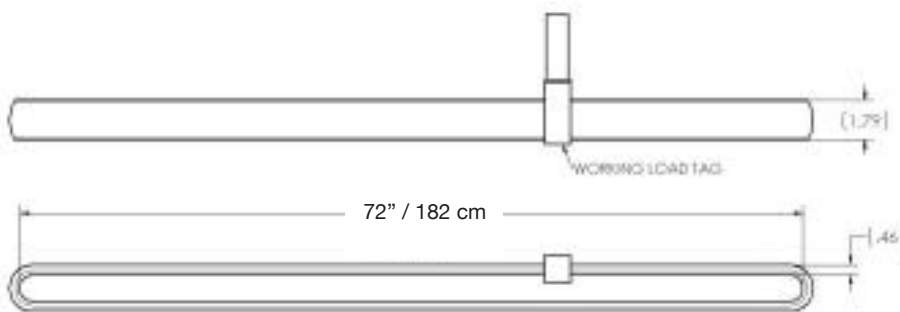

### SPECIFICATIONS:

**Length:** 6' Feet

**Cover:** Fabric

**Color:** Black

**Design Factor:** 5:1

**Basket WL:** 10,600 lb / 4818 Kg

**Vertical WL:** 5300 lb / 2409 Kg

**Choker WL:** 4240 lb / 1927 Kg



MADE IN USA



Rated for indoor use.



Basket



Vertical



Choker

### ALWAYS INSTALL SAFETY CABLES

**WARNING:** Mounting and/or suspension of audio and video equipment requires experienced professionals. Improperly installed loudspeakers can result in property damage, personal injury and/or liability to the installing contractor.