

SB-30

SUSPENSION & AIMING FOR SINGLE CABINETS

545 lb. WLL

Steerables®



STEERABLE SUSPENSION SYSTEM

The SwivelBeam is an easy to use load-rated and off the shelf loudspeaker rigging and aiming system from single loudspeakers to full line arrays. It is ideal for aiming sound in left and right of house configurations and provides side and backfills where speakers cannot be wall mounted.

The upper cross arm of the SwivelBeam rigs from two overhead suspension points. The lower cross arm supports the loudspeaker and rotates relative to the upper section, horizontally, up to 360°. This gives the installer precise horizontal aiming of sound. For precise vertical aiming, a self-contained cabinet located behind the lower cross arm.

Typical venues include theatres, churches, school auditoriums, gymnasiums, sport arenas, meeting halls and theme park attractions.

STANDARD FEATURES:

- ▶ Central pivot for steering
- ▶ Rear pull back point for tilting
- ▶ Rugged Steel Construction
- ▶ Powder Coat Finish

OPTIONAL ACCESSORIES:

- ▶ Wire Rope Supplies
- ▶ Eyebolts, Shackles, Turnbuckles
- ▶ Beam Clamps, Swivel Rings, Truss Clamps

SPECIFICATIONS:

Materials: Alloy Structural Steel Tube
Finish: Powder Coat Paint
Paint Color: Black
WLL: 545 lb / 248 Kg
Design Factor: 7:1
Product Weight: 34.6 lb / 15.7 Kg

PACKAGE CONTENTS:

1 pc. Swivel Beam



DIMENSIONS:

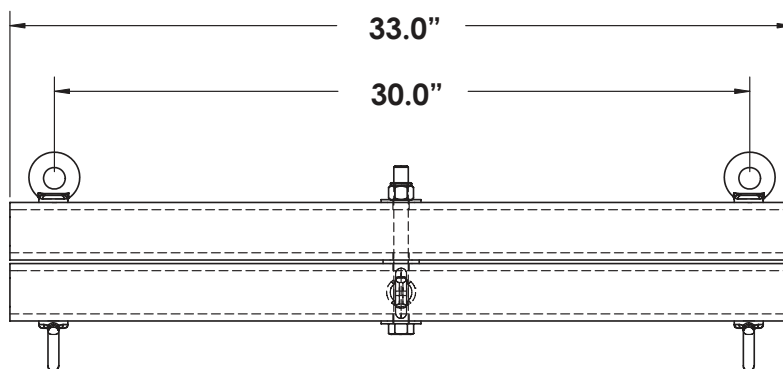

Front View

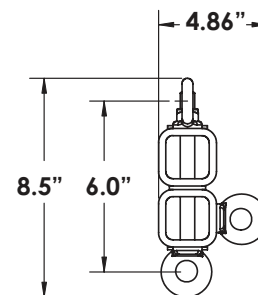

Standard Pull-Back Configuration

ALWAYS INSTALL SAFETY CABLES

WARNING: Mounting and/or suspension of audio and video equipment requires experienced professionals. Improperly installed loudspeakers can result in property damage, personal injury and/or liability to the installing contractor.

SB-30

SUSPENSION & AIMING FOR SINGLE CABINETS

545 lb. WLL

Steerables®

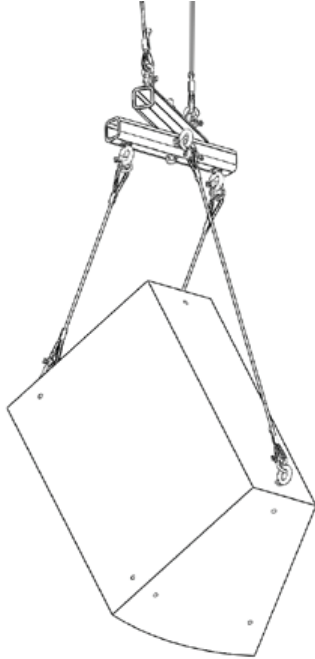

SWIVEL BEAM - USING SINGLE TILT CABLE KIT ASSEMBLY

Fly medium to large speaker cabinets in a vertical orientation using narrow model SwivelBeams as a load-rated suspension and steering device. The SwivelBeam's upper arm provides all the suspension strength from two points that secure to any overhead structural member such as an I-Beam while the lower arm rotates horizontally to aim the speaker into the desired direction. A third attach point on the lower arm provides a way to tilt the speaker downward and into the desired angle.

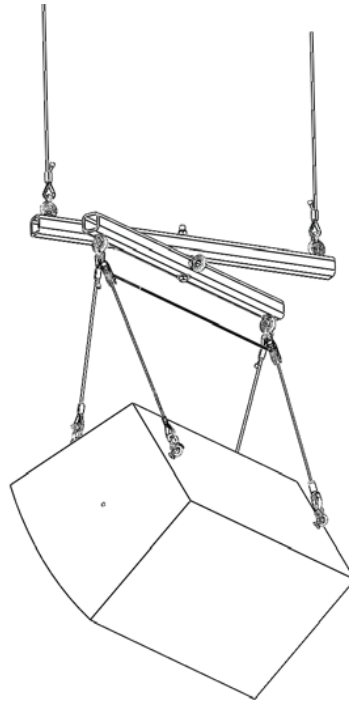

SWIVEL BEAM - USING DOUBLE TILT CABLE KIT ASSEMBLY

Fly medium to large speaker cabinets in the horizontal orientation using wider model SwivelBeams as a load-rated suspension and steering device. The SwivelBeam's upper arm provides all the suspension strength from two points that secure to any overhead structural member such as an I-Beam while the lower arm rotates horizontally to aim the speaker into the desired direction. A third and fourth attach point on the lower arm provides a way to tilt the speaker downward and into the desired angle.

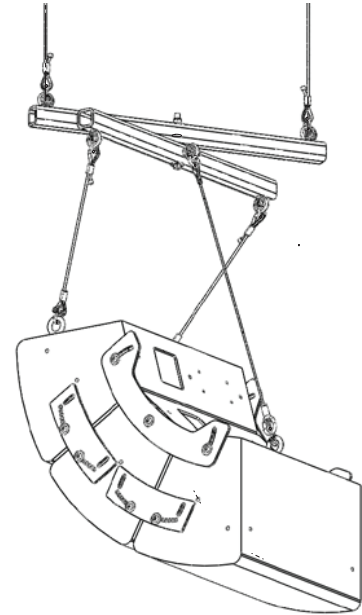

SWIVEL BEAM - USING WIRE ROPE TO FLY LINE ARRAYS

Fly medium size line arrays using wider model SwivelBeams as a load-rated suspension and steering device. The SwivelBeam's upper arm provides all the suspension strength from two points that secure to any overhead structural member such as an I-Beam while the lower arm rotates horizontally to aim the line array into the desired direction. A third attach point on the lower arm provides a pull back to tilt the line array into the desired down-angle.