

SK-375-S

(2000 lb. WLL)

3/8" SHACKLE - SCREW PIN ANCHOR

SHACKLE



The screw pin version of shackle is ideal for the joining of two closed-end items together, such as wire rope assemblies, turnbuckles and eyebolts. The small hole in its pin offers a back up safety feature by securing a wire or cable tie through the holes and around the body of the shackle. This prevents the pin from loosening through vibration and is known as "mousing" the shackle. Shackles are rated for overhead suspensions because of this redundant locking feature and the radius portion of their body structurally accommodates three way bridles.

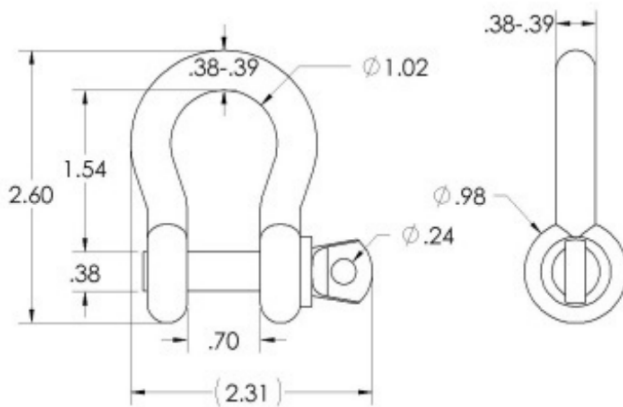

SPECIFICATIONS:

Diameter:	3/8"
Color:	Silver
Design Factor:	6:1
WLL:	2000 lb / 909 Kg



Rated for outdoor use.

ALWAYS INSTALL SAFETY CABLES

WARNING: Mounting and/or suspension of audio and video equipment requires experienced professionals. Improperly installed loudspeakers can result in property damage, personal injury and/or liability to the installing contractor.