

# SL-750

# 3600 lb. WLL

## 3/4" PEAR SHAPED SLING LINKS

## LINKS, PEAR & END



Weldless Pear Link

Weldless sling links are produced from a single piece of metal so there is no chance for weld failure. This high strength load rated link is ideal for use in bridling two points (from the wider end), at angles from a third point (at the narrower end), such as with shackles or wire rope assemblies.



Bridle Rigging

### KEY FEATURES:

- ▶ High Strength
- ▶ Weldless
- ▶ 3-Point Suspension

### OPTIONAL ACCESSORIES:

- ▶ See SK Series Shackles
- ▶ See QL Series Quick Links

### SPECIFICATIONS:

**Diameter:** 3/4"

**Material:** Forged Carbon Steel

**Finish:** Galvanized

**WLL:** 3600 lb / 1636 Kg

**Design Factor:** 10:1

### PACKAGE CONTENTS:

**1pc** 3/4" Sling Link



Rated for indoor use.

### DIMENSIONS:

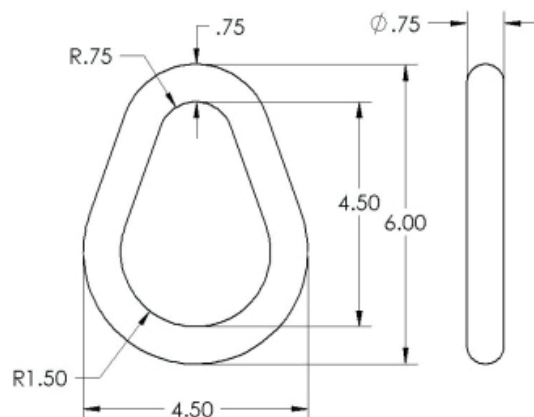

### ALWAYS INSTALL SAFETY CABLES

**WARNING:** Mounting and/or suspension of audio and video equipment requires experienced professionals. Improperly installed loudspeakers can result in property damage, personal injury and/or liability to the installing contractor.