

TB-375-JE

(1200 lb. WLL)

3/8" TURNBUCKLE - JAW TO EYE

TURNBUCKLES



Turnbuckles serve as a load-rated tensioning and leveling device. For tensioning, one end always comes with a reversed thread so that when it is placed into service between two objects in its fully extended position, the housing may be rotated back to shorten the overall component, pulling the threaded arms in and putting additional tension into the system, such as between two anchored wire rope assemblies.

Turnbuckles are also employed as leveling devices to bring overhead truss and grids into a level attitude. Its eye fittings accommodate shackles, quick links, etc.



STANDARD FEATURES:

- ▶ Made for in-line or straight pull applications only

SPECIFICATIONS:

Diameter: 3/8"

Color: Silver

Design Factor: 5:1

WLL: 1200 lb / 545 Kg

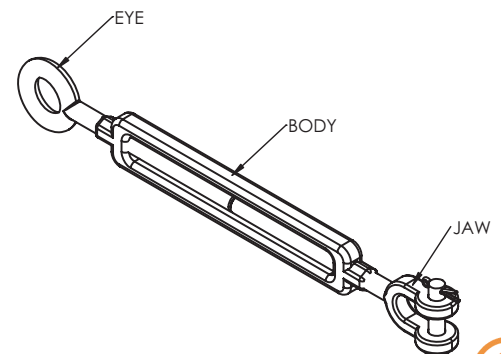
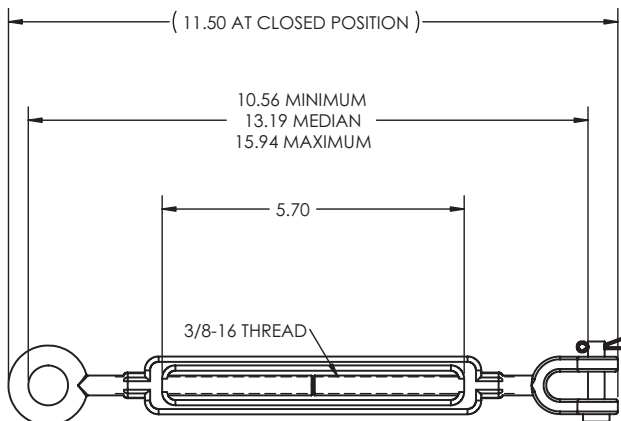

Rated for outdoor use.

ALWAYS INSTALL SAFETY CABLES

WARNING: Mounting and/or suspension of audio and video equipment requires experienced professionals. Improperly installed loudspeakers can result in property damage, personal injury and/or liability to the installing contractor.