

TB-375-JJ

1200 lb WLL

3/8" TURNBUCKLE - JAW TO JAW

TURNBUCKLES



Leveler / Tensioner

Turnbuckles serve as a load-rated tensioning and leveling device. For tensioning, one end always comes with a reversed thread so that when it is placed into service between two objects in its fully extended position, the housing may be rotated back to shorten the overall component, pulling the threaded arms in and putting additional tension into the system, such as between two anchored wire rope assemblies. Turnbuckles are also employed as leveling devices to bring overhead truss and grids into a level attitude. Its clevis fittings accommodate wire rope assemblies, rigging chain and other closed end devices.

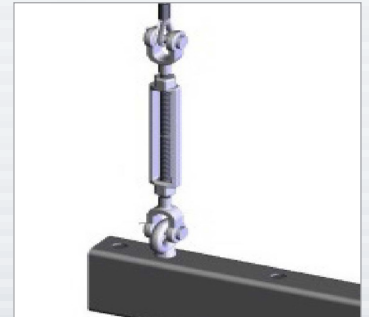

STANDARD FEATURES:

- ▶ Outdoor rated - non marine
- ▶ Forged Clevis Ends
- ▶ Up to 5-1/2" of adjustment

OPTIONAL ACCESSORIES:

- ▶ See Shackle datasheet
- ▶ See Wire Rope datasheet
- ▶ See Beam Clamp datasheet
- ▶ See Rigging Beam datasheet
- ▶ See GridLink® datasheet

SPECIFICATIONS:

Material: Forged Steel
Finish: Galvanized
Color: Silver
WLL: 1200 lb / 545 Kg
Design Factor: 5:1

PACKAGED CONTENTS:

1 pc. Turnbuckle Jaw to Jaw



Rated for outdoor use.

DIMENSIONS:

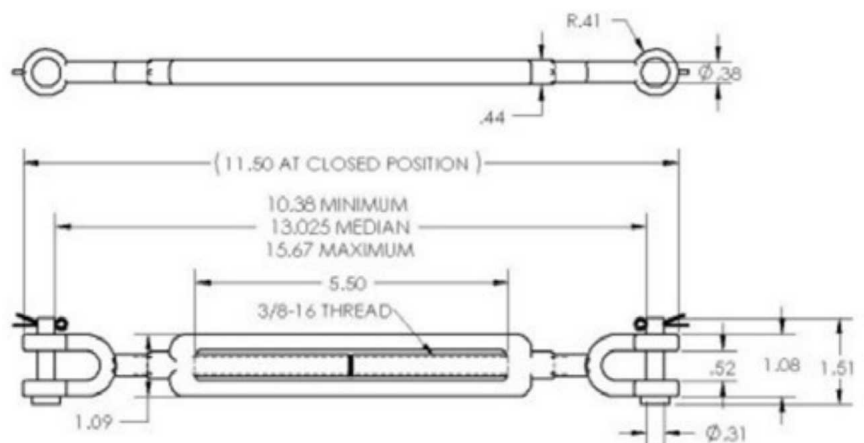

Adaptive Technologies Group
1635 E. Burnett Street | Signal Hill, CA 90755 USA
Ph: 562.424.1100 | Fax: 562.424.3520
www.adaptivetechgroup.com



ALWAYS INSTALL SAFETY CABLES

WARNING: Mounting and/or suspension of audio and video equipment requires experienced professionals. Improperly installed loudspeakers can result in property damage, personal injury and/or liability to the installing contractor.